

# CONTENTS

	PAGE
<b>Single deflection grilles</b> _____	<b>4</b>
<b>Double deflection grilles</b> _____	<b>5</b>
Quick selection table _____	<b>6</b>
General information _____	<b>8</b>
Accessories and mounting _____	<b>10</b>
<b>Grilles for circular ducts</b> _____	<b>12</b>
Quick selection table _____	<b>13</b>
General information _____	<b>14</b>
<b>Information of general interest</b> _____	<b>18</b>

# Single deflection grilles (SUPPLY)

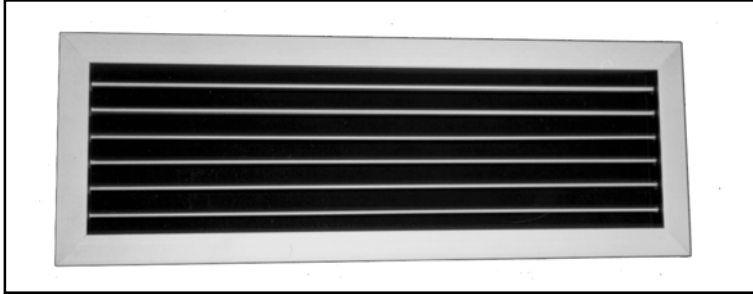

## Description

Type 20-SH aluminium grilles, adjustable blades  
 Type 21-SH steel sheet grilles, adjustable blades

## Finishes

Anodised aluminium in its natural colour.  
 Steel sheet painted in white RAL 9010.  
 Special finishes available upon request.

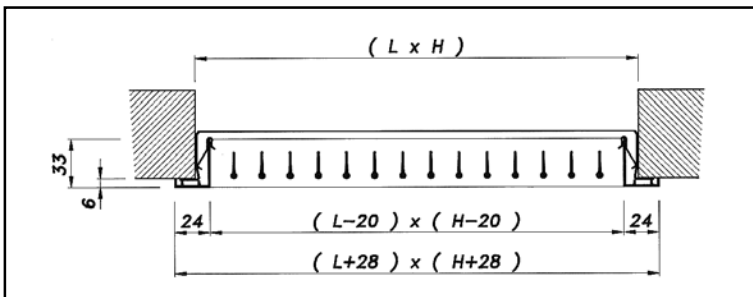

## Dimensions for use with mounting frame

When the grilles are fixed with a metal frame, the size of the opening corresponds to the nominal size of the grilles. For example, a grille of 500 x 300 would require an opening of the same dimensions.

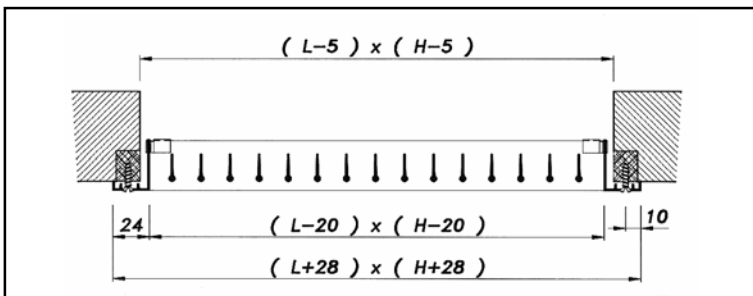

## Dimensions for screw mounting

When the grilles are fixed with screws, the size of the opening corresponds to the nominal size of the grilles reduced by 5mm in both length and height. For example, a grille of 500 x 300 would require an opening of 495 x 295.

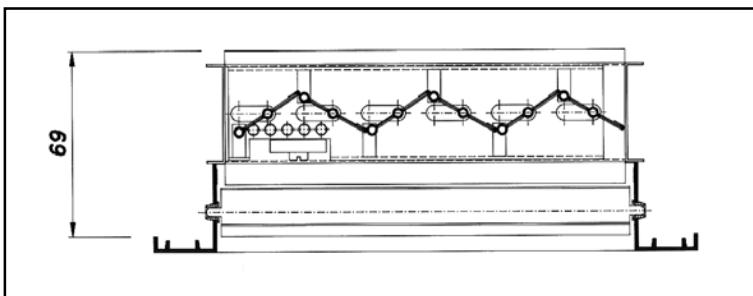

## Single deflection with volume control damper

The damper is actuated from the front by a screw driver.

<b>20</b> <b>21</b>	Series, aluminium grille Series, steel sheet grille
<b>SH</b> <b>SV</b>	Single deflection with horizontal blades Single deflection with vertical blades
<b>O</b>	Without indication, not incorporated Volume control damper type 29-0
<b>MM</b> With MM For MM	Without indication, the grille is provided with holes for screwing Mounting frame The grille is supplied with mounting frame The grille is supplied without mounting frame, but it is prepared for its usage
<b>L x H</b>	Length in mm (horizontal direction) x height in mm (vertical direction)

## Identification

All grille dimensions are defined by length (L) and followed by height (H). L x H is the dimension of the free opening. When the grille does not incorporate a mounting frame but is prepared for screwing, the dimension of the opening will be L-5 mm x H-5 mm.

# Double deflection grilles (SUPPLY)

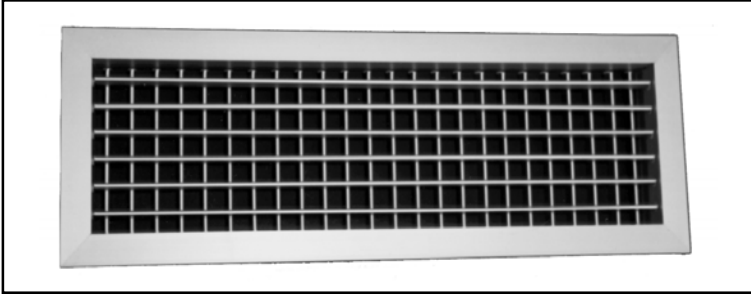

## Description

Type 20-DH aluminium grilles, adjustable blades  
Type 21-DH steel sheet grilles, adjustable blades

## Finishes

Anodised aluminium in its natural colour.  
Steel sheet painted in white RAL 9010.  
Special finishes available upon request.

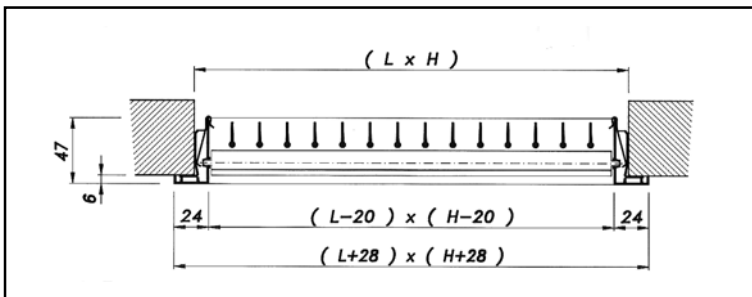

## Dimensions for use with mounting frame

When the grilles are fixed with a metal frame, the size of the opening corresponds to the nominal size of the grilles. For example, a grille of 500 x 300 would require an opening of the same dimensions.

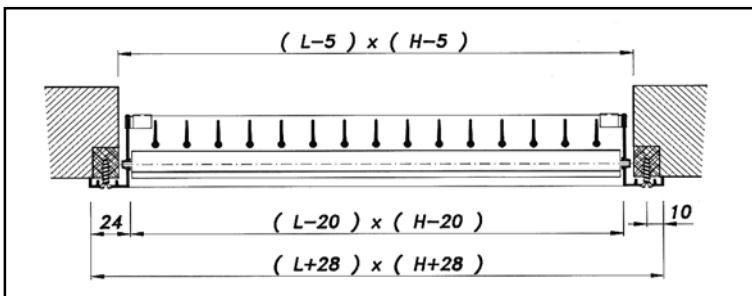

## Dimensions for screw mounting

When the grilles are fixed with screws, the size of the opening corresponds to the nominal size of the grilles reduced by 5mm in both length and height. For example, a grille of 500 x 300 would require an opening of 495 x 295.

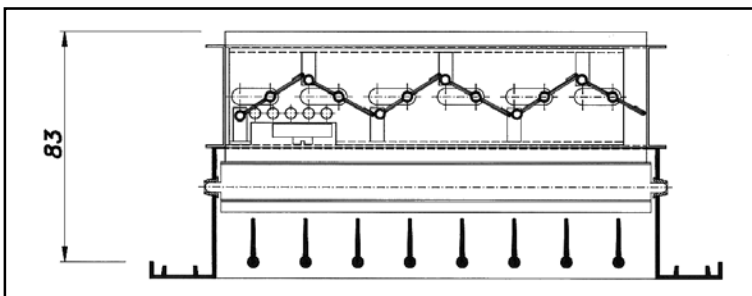

## Double deflection with volume control damper

The damper is actuated from the front by a screw driver.

<b>20</b> <b>21</b>	Series, aluminium grille Series, steel sheet grille
<b>DH</b> <b>DV</b>	Double deflection with horizontal blades Double deflection with vertical blades
<b>O</b>	Without indication, not incorporated Volume control damper type 29-0
<b>MM</b> <b>With MM</b> <b>For MM</b>	Without indication, the grille is provided with holes for screwing Mounting frame The grille is supplied with mounting frame The grille is supplied without mounting frame, but it is prepared for its usage
<b>L x H</b>	Length in mm (horizontal direction) x height in mm (vertical direction)

## Identification

All grille dimensions are defined by length (L) and followed by height (H). L x H is the dimension of the free opening. When the grille does not incorporate a mounting frame but is prepared for screwing, the dimension of the opening will be L-5 mm x H-5 mm.

# QUICK SELECTION TABLE (DOUBLE DEFLECTION)

Dim. (mm)		200x100	250x100	300x100 200x150	250x150	300x150	350x150 250x200	600x100 400x150 300x200	500x150 350x200	600x150 450x200 350x250 300x300	600x200 500x250 400x300	1000x150 750x200 600x250 500x300	1200x150 900x200 750x250 600x300	1100x200 900x250 750x300	1200x250 1000x300	
Q	A <sub>k</sub> (m <sup>2</sup> )	0,0098	0,0125	0,0148	0,0183	0,0224	0,0262	0,0309	0,0381	0,0474	0,0660	0,0801	0,0970	0,1210	0,1670	
(m <sup>3</sup> /h)	α (°)	0 30	0 30	0 30	0 30	0 30	0 30	0 30	0 30	0 30	0 30	0 30	0 30	0 30	0 30	
100	27,8	V <sub>k</sub> (m/s) X (m) P <sub>t</sub> (Pa) NR (dB)	2,8 2,8 2,2 1,8 3,2 3,9 10 12	2,2 2,2 1,9 1,6 2,0 2,4 5 7	1,9 1,9 1,8 1,4 1,4 1,7	1,5 1,5 1,6 1,3 0,9 1,1	1,2 1,2 1,5 1,2 0,6 0,7	1,1 1,1 1,3 1,1 0,4 0,5	0,9 0,9 1,2 1,0 0,3 0,4	0,7 0,7 1,1 0,9 0,2 0,3	0,6 0,6 1,0 0,8 0,1 0,2					
150	41,7	V <sub>k</sub> (m/s) X (m) P <sub>t</sub> (Pa) NR (dB)	4,3 4,3 3,3 2,6 7,2 8,7 20 22	3,3 3,3 2,9 2,3 4,4 5,3 15 17	2,8 2,8 2,7 2,1 3,2 3,8 12 14	2,3 2,3 2,4 1,9 2,1 2,5 8 10	1,9 1,9 2,2 1,7 1,4 1,7 4 6	1,6 1,6 2,0 1,6 1,0 1,2	1,3 1,3 1,9 1,5 0,7 0,9	1,1 1,1 1,7 1,3 0,5 0,6	0,9 0,9 1,5 1,2 0,3 0,4	0,8 0,8 1,3 1,0 0,2 0,2				
200	55,6	V <sub>k</sub> (m/s) X (m) P <sub>t</sub> (Pa) NR (dB)	5,7 5,7 4,4 3,5 12,9 15,4 27 29	4,4 4,4 3,9 3,1 7,9 9,5 22 24	3,8 3,8 3,6 2,9 5,6 6,8 19 21	3,0 3,0 2,5 2,6 3,7 4,4 15 17	2,5 2,5 2,9 2,3 2,5 3,0 11 13	2,1 2,1 2,7 2,2 1,8 2,2 8 10	1,8 1,8 2,5 2,0 1,3 1,6 5 7	1,5 1,5 2,2 1,8 0,9 1,0	1,2 1,2 2,0 1,6 0,5 0,7	0,8 0,8 1,7 1,4 0,3 0,3	0,7 0,7 1,5 1,2 0,2 0,2			
250	69,4	V <sub>k</sub> (m/s) X (m) P <sub>t</sub> (Pa) NR (dB)	7,1 7,1 5,5 4,4 20,1 24,1 33 35	5,6 5,6 4,9 3,9 12,3 14,8 28 30	4,7 4,7 4,5 3,6 8,8 10,6 24 26	3,8 3,8 4,0 3,2 5,8 6,9 20 22	3,1 3,1 3,6 2,9 3,8 4,6 16 18	2,7 2,7 3,4 2,7 2,8 3,4 13 15	2,2 2,2 3,1 2,5 2,0 2,4 10 12	1,8 1,8 2,8 2,2 1,3 1,6 6 8	1,5 1,5 2,5 2,0 0,9 1,0	1,1 1,1 2,1 1,7 0,4 0,5	0,9 0,9 1,9 1,5 0,3 0,4			
300	83,3	V <sub>k</sub> (m/s) X (m) P <sub>t</sub> (Pa) NR (dB)	8,5 8,5 6,6 5,3 28,9 34,7 37 39	6,7 6,7 5,8 4,7 17,8 21,3 32 34	5,6 5,6 5,4 4,3 12,7 15,2 29 31	4,6 4,6 4,8 3,9 8,3 10,0 25 27	3,7 3,7 4,4 3,5 5,5 6,6 21 23	3,2 3,2 4,0 3,2 4,0 4,9 18 20	2,7 2,7 3,7 3,0 2,9 3,5 15 17	2,2 2,2 3,3 2,7 1,9 2,3 10 12	1,8 1,8 3,0 2,4 1,2 1,5 6 8	1,3 1,3 2,5 2,0 0,6 0,8	1,0 1,0 2,3 1,8 0,4 0,5	0,9 0,9 2,1 1,7 0,3 0,4		
350	97,2	V <sub>k</sub> (m/s) X (m) P <sub>t</sub> (Pa) NR (dB)	9,9 9,9 7,7 6,2 39,4 47,2 41 43	7,8 7,8 6,8 5,5 24,2 29,0 36 38	6,6 6,6 6,3 5,0 17,3 20,7 33 35	5,3 5,3 5,6 4,5 11,3 13,5 29 31	4,3 4,3 5,1 4,1 7,5 9,0 25 27	3,7 3,7 4,7 3,8 5,5 6,6 21 23	3,1 3,1 4,3 3,5 4,0 4,8 18 20	2,6 2,6 3,9 3,1 2,6 3,1 14 16	2,1 2,1 3,5 2,8 1,7 2,0 10 12	1,5 1,5 3,0 2,4 0,9 1,0	1,2 1,2 2,7 2,2 0,6 0,7	1,0 1,0 2,4 2,0 0,4 0,5		
400	111,1	V <sub>k</sub> (m/s) X (m) P <sub>t</sub> (Pa) NR (dB)	11,3 11,3 8,8 7,0 51,4 61,7 44 46	8,9 8,9 7,8 6,2 31,6 37,9 39 41	7,5 7,5 7,2 5,7 22,5 27,1 36 38	6,1 6,1 6,4 5,1 14,7 17,7 32 34	5,0 5,0 5,8 4,7 9,8 11,8 28 30	4,2 4,2 5,4 4,3 7,2 8,6 25 27	3,6 3,6 5,0 4,0 8,6 10,2 22 24	2,9 2,9 4,5 3,6 3,4 4,1 17 19	2,3 2,3 4,0 3,2 2,2 2,6 13 15	1,7 1,7 3,4 2,7 1,4 1,4 7 9	1,4 1,4 3,1 2,5 0,8 0,9	1,1 1,1 2,8 2,2 0,5 0,6	0,9 0,9 2,5 2,0 0,3 0,4	
450	125,0	V <sub>k</sub> (m/s) X (m) P <sub>t</sub> (Pa) NR (dB)		10,0 10,0 8,8 7,0 40,0 48,0 42 44	8,4 8,4 8,1 6,4 28,5 34,2 39 41	6,8 6,8 7,2 5,8 18,7 22,4 35 37	5,6 5,6 6,5 5,2 12,5 14,9 31 33	4,8 4,8 6,1 4,8 9,1 10,9 24 26	4,0 4,0 5,6 4,5 6,5 7,9 24 26	3,3 3,3 5,0 4,0 4,3 5,2 20 22	2,6 2,6 4,5 3,6 2,8 3,3 14 16	1,9 1,9 3,8 3,1 1,4 1,7 10 12	1,6 1,6 3,5 2,8 1,0 1,2 6 8	1,3 1,3 3,1 2,5 0,7 0,8	1,0 1,0 2,8 2,3 0,4 0,5	
500	138,9	V <sub>k</sub> (m/s) X (m) P <sub>t</sub> (Pa) NR (dB)		11,1 11,1 9,7 7,8 49,4 59,3	9,4 9,4 8,9 7,2 35,2 42,3 41 43	7,6 7,6 8,0 6,4 23,0 27,6 37 39	6,2 6,2 7,3 5,8 15,4 18,5 33 35	5,3 5,3 6,7 5,4 11,2 13,5 30 32	4,5 4,5 6,2 5,0 8,1 9,7 27 29	3,6 3,6 5,6 4,5 5,3 6,4 23 25	2,9 2,9 4,0 4,0 3,4 4,1 19 21	2,1 2,1 4,2 3,4 1,8 2,1 12 14	1,7 1,7 3,8 3,1 1,2 1,4 8 10	1,4 1,4 3,5 2,8 0,8 1,0 5 7	1,1 1,1 3,1 2,5 0,5 0,6	0,8 0,8 2,7 2,1 0,3 0,3
550	152,8	V <sub>k</sub> (m/s) X (m) P <sub>t</sub> (Pa) NR (dB)		10,3 10,3 9,8 7,9 42,6 51,1 44 46	8,3 8,3 8,9 7,1 27,9 33,5 39 41	6,8 6,8 8,0 6,4 18,6 22,3 36 38	5,8 5,8 8,0 6,4 13,6 16,3 32 34	4,9 4,9 6,8 5,4 9,8 11,7 29 31	4,0 4,0 5,6 4,5 6,4 7,7 25 27	4,0 4,0 5,5 4,4 4,2 5,0 21 23	3,2 3,2 4,7 3,7 2,1 2,6 14 16	2,3 2,3 4,2 3,4 1,5 1,7 11 13	1,9 1,9 4,6 3,7 2,6 3,4 8 10	1,6 1,6 3,8 3,1 1,0 1,2 7 9	1,3 1,3 3,4 2,8 0,6 0,8	0,9 0,9 2,9 2,3 0,3 0,4
600	166,7	V <sub>k</sub> (m/s) X (m) P <sub>t</sub> (Pa) NR (dB)		11,3 11,3 10,7 8,6 50,7 60,9 46 48	9,1 9,1 9,7 7,7 33,2 39,8 42 44	7,4 7,4 8,0 6,4 22,1 26,6 38 40	6,4 6,4 7,4 5,9 16,2 19,4 35 37	5,4 5,4 7,4 5,9 11,6 14,0 31 33	4,4 4,4 6,7 5,4 7,7 9,2 27 29	4,4 4,4 6,0 4,8 4,9 5,9 23 25	3,5 3,5 5,0 4,0 2,6 3,1 17 19	2,5 2,5 4,6 3,7 1,7 2,1 13 15	2,1 2,1 4,7 3,7 1,2 1,4 9 11	1,7 1,7 4,2 3,4 1,2 1,4 5 7	1,4 1,4 3,8 3,0 0,8 0,9 7 9	1,0 1,0 3,2 2,6 0,4 0,5
650	180,6	V <sub>k</sub> (m/s) X (m) P <sub>t</sub> (Pa) NR (dB)		12,2 12,2 11,6 9,3 59,5 71,4 48 50	9,9 9,9 10,5 8,4 38,9 46,7 44 46	8,1 8,1 9,5 7,6 26,0 31,2 40 42	6,9 6,9 8,7 7,0 19,0 22,8 37 39	5,8 5,8 8,0 6,4 13,7 16,4 33 35	4,7 4,7 7,2 5,8 9,0 10,8 29 31	3,8 3,8 6,5 5,2 5,8 7,0 25 27	2,7 2,7 5,5 4,4 3,0 3,6 18 20	2,3 2,3 4,0 3,2 2,0 2,4 15 17	1,9 1,9 4,5 3,6 1,4 1,7 11 13	1,5 1,5 4,1 3,3 0,9 1,1 7 9	1,1 1,1 3,5 2,8 0,5 0,6	
700	194,4	V <sub>k</sub> (m/s) X (m) P <sub>t</sub> (Pa) NR (dB)		10,6 10,6 11,3 9,0 45,2 54,2 45 47	8,3 8,3 9,0 7,4 27,9 33,5 44 46	6,8 6,8 8,0 6,4 18,6 22,3 40 42	5,8 5,8 8,0 6,4 13,6 16,3 37 39	4,9 4,9 6,8 5,4 9,8 11,7 33 35	4,0 4,0 5,6 4,5 6,4 7,7 29 31	4,0 4,0 5,5 4,4 4,2 5,0 25 27	3,2 3,2 4,7 3,7 2,1 2,6 14 16	2,3 2,3 4,2 3,4 1,5 1,7 11 13	1,9 1,9 4,6 3,7 2,6 3,4 8 10	1,6 1,6 3,8 3,1 1,0 1,2 7 9	1,3 1,3 3,4 2,8 0,6 0,8	0,9 0,9 2,9 2,3 0,3 0,4
750	208,3	V <sub>k</sub> (m/s) X (m) P <sub>t</sub> (Pa) NR (dB)		11,4 11,4 12,1 9,7 51,8 62,2 47 49	9,9 9,9 10,9 8,7 34,6 41,5 43 45	8,1 8,1 9,5 7,6 26,0 31,2 40 42	6,9 6,9 8,7 7,0 19,0 22,8 37 39	5,8 5,8 8,0 6,4 13,7 16,4 33 35	4,7 4,7 7,2 5,8 9,0 10,8 31 33	3,8 3,8 6,5 5,2 5,8 7,0 25 27	2,7 2,7 5,5 4,4 3,0 3,6 18 20	2,3 2,3 4,0 3,2 2,0 2,4 15 17	1,9 1,9 4,5 3,6 1,4 1,7 11 13	1,5 1,5 4,1 3,3 0,9 1,1 7 9	1,1 1,1 3,5 2,8 0,5 0,6	
800	222,2	V <sub>k</sub> (m/s) X (m) P <sub>t</sub> (Pa) NR (dB)		10,5 10,5 12,4 9,9 44,4 53,3 46 48	9,0 9,0 11,4 9,1 32,5 39,0 43 45	8,7 8,7 10,2 8,1 30,1 36,2 40 42	7,4 7,4 9,4 7,5 22,0 26,4 38 40	6,3 6,3 8,1 6,9 15,8 19,0 35 37	5,1 5,1 7,8 6,2 10,4 12,5 31 33	4,1 4,1 6,0 5,6 7,0 8,1 27 29	3,2 3,2 5,9 4,7 3,5 4,2 20 22	2,3 2,3 4,9 3,9 2,4 2,8 17 19	1,9 1,9 5,2 4,2 1,6 1,9 13 15	1,6 1,6 4,4 3,5 1,0 1,2 8 10	1,2 1,2 3,7 3,0 0,5 0,7	
850	236,1	V <sub>k</sub> (m/s) X (m) P <sub>t</sub> (Pa) NR (dB)		11,4 11,4 12,1 9,7 51,8 62,2 47 49	9,9 9,9 10,9 8,7 34,6 41,5 43 45	8,1 8,1 9,5 7,6 26,0 31,2 40 42	6,9 6,9 8,7 7,0 19,0 22,8 37 39	5,8 5,8 8,0 6,4 13,7 16,4 33 35	4,7 4,7 7,2 5,8 9,0 10,8 31 33	3,8 3,8 6,5 5,2 5,8 7,0 25 27	2,7 2,7 5,5 4,4 3,0 3,6 18 20	2,3 2,3 4,0 3,2 2,0 2,4 15 17	1,9 1,9 4,5 3,6 1,4 1,7 11 13	1,5 1,5 4,1 3,3 0,9 1,1 7 9	1,1 1,1 3,5 2,8 0,5 0,6	
900	250,0	V <sub>k</sub> (m/s) X (m) P <sub>t</sub> (Pa) NR (dB)		10,6 10,6 11,3 9,0 45,2 54,2 45 47	8,3 8,3 9,0 7,4 27,9 33,5 44 46	6,8 6,8 8,0 6,4 18,6 22,3 40 42	5,8 5,8 8,0 6,4 13,6 16,3 37 39	4,9 4,9 6,8 5,4 9,8 11,7 33 35	4,0 4,0 5,6 4,5 6,4 7,7 29 31	4,0 4,0 5,5 4,4 4,2 5,0 25 27	3,2 3,2 4,7 3,7 2,1 2,6 14 16	2,3 2,3 4,2 3,4 1,5 1,7 11 13	1,9 1,9 4,6 3,7 2,6 3,4 8 10	1,6 1,6 3,8 3,1 1,0 1,2 7 9	1,3 1,3 3,4 2,8 0,6 0,8	0,9 0,9 2,9 2,3 0,3 0,4
950	263,9	V <sub>k</sub> (m/s) X (m) P <sub>t</sub> (Pa) NR (dB)		11,4 11,4 12,1 9,7 51,8 62,2 47 49	9,9 9,9 10,9 8,7 34,6 41,5 43 45	8,1 8,1 9,5 7,6 26,0 31,2 40 42	6,9 6,9 8,7 7,0 19,0 22,8 37 39	5,8 5,8 8,0 6,4 13,7 16,4 33 35	4,7 4,7 7,2 5,8 9,0 10,8 31 33	3,8 3,8 6,5 5,2 5,8 7,0 25 27	2,7 2,7 5,5 4,4 3,0 3,6 18 20	2,3 2,3 4,0 3,2 2,0 2,4 15 17	1,9 1,9 4,5 3,6 1,4 1,7 11 13	1,5 1,5 4,1 3,3 0,9 1,1 7 9	1,1 1,1 3,5 2,8 0,5 0,6	
1000	277,8	V <sub>k</sub> (m/s) X (m) P <sub>t</sub> (Pa) NR (dB)		10,6 10,6 11,3 9,0 45,2 54,2 45 47	8,3 8,3 9,0 7,4 27,9 33,5 44 46	6,8 6,8 8,0 6,4 18,6 22,3 40 42	5,8 5,8 8,0 6,4 13,6 16,3 37 39	4,9 4,9 6,8 5,4 9,8 11,7 33 35	4,0 4,0 5,6 4,5 6,4 7,7 29 31	4,0 4,0 5,5 4,4 4,2 5,0 25 27	3,2 3,2 4,7 3,7 2,1 2,6 14 16	2,3 2,3 4,2 3,4 1,5 1,7 11 13	1,9 1,9 4,6 3,7 2,6 3,4 8 10	1,6 1,6 3,8 3,1 1,0 1,2 7 9	1,3 1,3 3,4 2,8 0,6 0,8	0,9 0,9 2,9 2,3 0,3 0,4
1100	305,6	V <sub>k</sub> (m/s) X (m) P <sub>t</sub> (Pa) NR (dB)		10,6 10,6 11,3 9,0 45,2 54,2 45 47	8,3 8,3 9,0 7,4 27,9 33,5 44 46	6,8 6,8 8,0 6,4 18,6 22,3 40 42	5,8 5,8 8,0 6,4 13,6 16,3 37 39	4,9 4,9 6,8 5,4 9,8 11,7 33 35	4,0 4,0 5,6 4,5 6,4 7,7 29 31	4,0 4,0 5,5 4,4 4,2 5,0 25 27	3,2 3,2 4,7 3,7 2,1 2,6 14 16	2,3 2,3 4,2 3,4 1,5 1,7 11 13	1,9 1,9 4,6 3,7 2,6 3,4 8 10	1,6 1,6 3,8 3,1 1,0 1,2 7 9	1,3 1,3 3,4 2,8 0,6 0,8	0,9 0,9 2,9 2,3 0,3 0,4

**Correction factors for single deflection grilles, 20-SH, 20-SV, 21-SH and 21-SV:**  
 $V_e = \text{Table value} \times 0,8$   
 $X = \text{Table value} \times 1,1$   
 $P = \text{Table value} \times 0,8$   
 $NR = \text{Table value} \times 0,9$

**Where :**  
 $V_e$  = Effective velocity in m/s  
 $X$  = Throw in m  
 $P$  = Total pressure loss in Pa  
 $NR$  = Sound level index in dB  
 $A_k$  = Effective area in m<sup>2</sup>

NR > 40                      NR 30 - 40                      NR 20 - 30

NR 10 - 20

Q		Dim. (mm)	200x100	250x100	300x100 200x150	250x150	300x150	350x150 250x200	600x100 400x150 300x200	500x150 350x200	600x150 450x200 350x250 300x300	600x200 500x250 400x300	1000x150 750x200 600x250 500x300	1200x150 900x200 750x250 600x300	1100x200 900x250 750x300	1200x250 1000x300						
(m³/h)	(l/s)	A <sub>k</sub> (m²)	0,0098	0,0125	0,0148	0,0183	0,0224	0,0262	0,0309	0,0381	0,0474	0,0660	0,0801	0,0970	0,1210	0,1670						
		α (°)	0 30	0 30	0 30	0 30	0 30	0 30	0 30	0 30	0 30	0 30	0 30	0 30	0 30	0 30						
1200	333,3	V <sub>k</sub> (m/s) X (m) P <sub>t</sub> (Pa) NR (dB)							10,8 10,8 14,9 11,9 46,5 55,9 48 50	8,7 8,7 13,4 10,7 30,6 36,7 44 46	7,0 7,0 12,0 9,6 19,8 23,7 40 42	5,1 5,1 10,2 8,1 6,9 8,3 33 35	4,2 4,2 9,2 7,4 4,7 5,7 30 32	3,4 3,4 8,4 6,7 4,7 5,7 26 28	2,8 2,8 7,5 6,0 3,0 3,6 22 24	2,0 2,0 6,4 5,1 1,6 1,9 15 17						
1300	361,1	V <sub>k</sub> (m/s) X (m) P <sub>t</sub> (Pa) NR (dB)							11,7 11,7 16,1 12,9 54,6 65,6 50 52	9,5 9,5 14,5 11,6 35,9 43,1 46 48	7,6 7,6 13,0 10,4 23,2 27,9 42 44	5,5 5,5 11,0 8,8 12,0 14,4 35 37	4,5 4,5 10,0 8,0 8,1 9,8 32 34	3,7 3,7 9,1 7,3 5,5 6,7 28 30	3,0 3,0 8,1 6,5 3,6 4,3 24 26	2,2 2,2 6,9 5,5 1,9 2,2 17 19						
1400	388,9	V <sub>k</sub> (m/s) X (m) P <sub>t</sub> (Pa) NR (dB)							12,6 12,6 17,3 13,9 63,4 76,0 52 54	10,2 10,2 15,6 12,5 41,7 50,0 48 50	8,2 8,2 14,0 11,2 26,9 32,3 44 46	5,9 5,9 11,9 9,5 13,9 16,7 37 39	4,9 4,9 10,8 8,6 9,4 11,3 33 35	4,0 4,0 9,8 7,8 6,4 7,7 30 32	3,2 3,2 8,8 7,0 4,1 5,0 25 27	2,3 2,3 7,5 6,0 2,2 2,6 19 21						
1500	416,7	V <sub>k</sub> (m/s) X (m) P <sub>t</sub> (Pa) NR (dB)							10,9 10,9 16,7 13,4 47,8 57,4 50 52	8,8 8,8 13,0 10,4 30,9 37,1 45 47	6,3 6,3 15,0 12,0 15,9 19,1 45 47	5,2 5,2 12,7 10,2 10,8 13,0 39 41	4,3 4,3 11,5 9,2 13,0 17,0 31 33	4,3 4,3 10,5 8,4 7,4 8,9 31 33	3,4 3,4 9,4 7,5 4,7 5,7 27 29	2,5 2,5 8,0 6,4 2,5 3,0 21 23						
1600	444,4	V <sub>k</sub> (m/s) X (m) P <sub>t</sub> (Pa) NR (dB)	<p><b>Correction factors for single deflection grilles, 20-SH, 20-SV, 21-SH and 21-SV:</b></p> <p>V<sub>k</sub> = Table value x 0,8 X = Table value x 1,1 P<sub>t</sub> = Table value x 0,8 NR = Table value x 0,9</p> <p><b>Where :</b></p> <p>V<sub>k</sub> = Effective velocity in m/s X = Throw in m P<sub>t</sub> = Total pressure loss in Pa NR = Sound level index in dB A<sub>k</sub> = Effective area in m²</p>																			
1700	472,2	V <sub>k</sub> (m/s) X (m) P <sub>t</sub> (Pa) NR (dB)																				
1800	500,0	V <sub>k</sub> (m/s) X (m) P <sub>t</sub> (Pa) NR (dB)																				
1900	527,8	V <sub>k</sub> (m/s) X (m) P <sub>t</sub> (Pa) NR (dB)																				
2000	555,6	V <sub>k</sub> (m/s) X (m) P <sub>t</sub> (Pa) NR (dB)																				
2100	583,3	V <sub>k</sub> (m/s) X (m) P <sub>t</sub> (Pa) NR (dB)																				
2200	611,1	V <sub>k</sub> (m/s) X (m) P <sub>t</sub> (Pa) NR (dB)																				
2400	666,7	V <sub>k</sub> (m/s) X (m) P <sub>t</sub> (Pa) NR (dB)																				
2600	722,2	V <sub>k</sub> (m/s) X (m) P <sub>t</sub> (Pa) NR (dB)																				
2800	777,8	V <sub>k</sub> (m/s) X (m) P <sub>t</sub> (Pa) NR (dB)																				
3000	833,3	V <sub>k</sub> (m/s) X (m) P <sub>t</sub> (Pa) NR (dB)																				
3200	888,9	V <sub>k</sub> (m/s) X (m) P <sub>t</sub> (Pa) NR (dB)																				
3500	972,2	V <sub>k</sub> (m/s) X (m) P <sub>t</sub> (Pa) NR (dB)																				
3800	1055,6	V <sub>k</sub> (m/s) X (m) P <sub>t</sub> (Pa) NR (dB)																				
4100	1138,9	V <sub>k</sub> (m/s) X (m) P <sub>t</sub> (Pa) NR (dB)																				
4500	1250,0	V <sub>k</sub> (m/s) X (m) P <sub>t</sub> (Pa) NR (dB)																				

NR 10 - 20

NR 20 - 30

NR 30 - 40

NR > 40

# General information

## Example:

### Requirements:

Air flow rate: \_\_\_\_\_ 450 m<sup>3</sup>/m  
 Throw: \_\_\_\_\_ 4 to 5m  
 Sound level: \_\_\_\_\_ below 30 NR  
 Application: \_\_\_\_\_ offices  
 Required pressure loss: \_\_\_\_\_ below 5 Pa  
 Effective velocity: \_\_\_\_\_ 2 to 3,5 m/s

### Solution:

With the selection table for supply grilles and following the general criterion that for comfort installations the discharge velocity of these grilles will be between 2 and 3,5 m/s, we obtain:

Air flow rate: \_\_\_\_\_ 450 m<sup>3</sup>/h (125 l/s)  
 V<sub>k</sub> (Effective velocity): \_\_\_\_\_ 3,3 m/s  
 X (Throw): \_\_\_\_\_ 5 m with 0° deflection  
 P<sub>t</sub> (Pressure loss): \_\_\_\_\_ 4,3 Pa  
 NR (Sound level): \_\_\_\_\_ 20 dB

Grille 20-DH or 20-DV of 500 x 100 or 350 x 200.

Observing the results, the data obtained fulfill the requirements of the project.

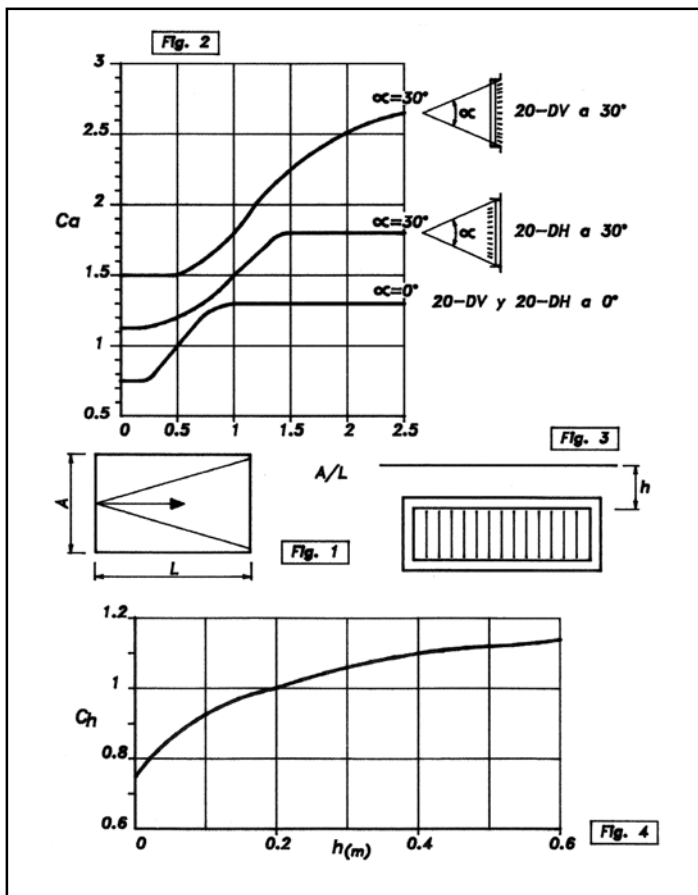

### Correction factors for throw.

Some correction factors exist as a function of the ratio between room width and length, the blade deflection angle and the distance from grille to ceiling, and are defined in the following manner:

A/L: Ratio between the width and the length of the room to be conditioned. For example, for a room with a width of 4,5 m and length of 4,5 m the factor A/L equals 1 (see Fig. 1).

C<sub>a</sub>: Factor obtained from the graph. For example, if the value of A/L = 1 and for a grille with 0° blade angle, the value of C<sub>a</sub> equals 1,3 (see Fig. 2)

C<sub>h</sub>: Correction factor for height, obtained from the distance between grille and ceiling. For a free jet C<sub>h</sub> is always 1,1. For example, if the grille is located at 0,2 m from the ceiling the factor C<sub>h</sub> equals 1 (see Fig. 3 and 4).

Once calculated these correction factors, the correction factor for the throw (K<sub>c</sub>) can be determined by the following formula:

$$K_c = C_a \cdot C_h \quad K_c = 1,3 \cdot 1 = 1,3$$

In this case of selection by table, we would obtain the corrected throw (X<sub>c</sub>):

$$X_c = K_c \cdot X \quad X_c = 1,3 \cdot X$$

## Usefull recommendations

### 1. Maximum distance h max.

To obtain an adhering jet with cold air, it is advisable not to exceed the distance of the grille with respect to the ceiling (h max.) and the temperature difference  $\Delta t$  (difference between room and supply air temperature) according to the following table.

$\Delta t$ (°C)	0	6	9	12
h max (m)	0,65	0,37	0,25	0,13

### 2. Maximum recommended velocity in occupied zone.

Due to the difference in the temperature of the air in the room with respect to the cold supply air, the following maximum velocities  $V_z$  are recommended (see following table).

		$\Delta t$ cold supply air (°C)			
		0	6	9	12
$V_z$ maximum recommended (m/s)	Grille in exterior wall	0,25	0,20	0,15	0,15
	Grille in interior wall	0,30	0,25	0,20	0,15

### 3. Flow rate measurement

The air flow rate ( $q_v$ ) is obtained from the product of the effective area of the grille ( $A_k$ ) and its effective velocity ( $V_k$ ):

$$q_v \text{ (m}^3\text{/h)} = A_k \text{ (m}^2\text{)} \cdot V_k \text{ (m/s)} \cdot 3600$$

To calculate  $A_k$  for grilles which are not included in the tables the following figure can be used.

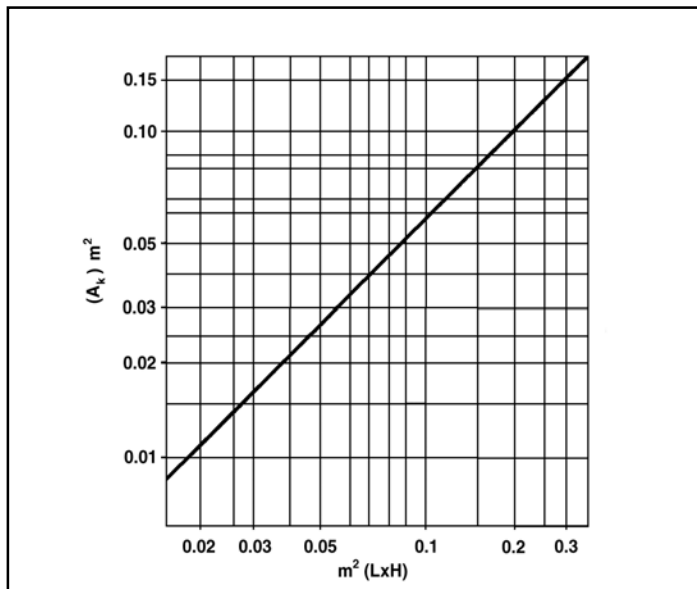

For supply grilles with a nominal area higher than 0,35 m<sup>2</sup> the  $A_k$  will be 70% of this area.

To obtain  $V_k$  use is recommended of a probe Alnor 2220 or 6070 P.

If a hot-wire anemometer is used (e.g. type TSI-VELOCICALC), the velocity obtained should be multiplied by 1,3.

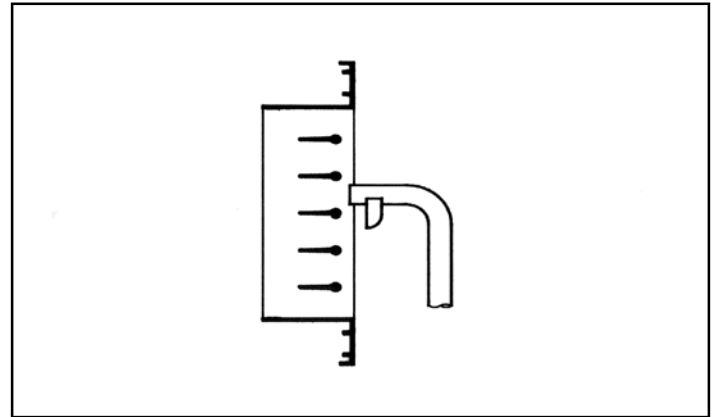

### 4. Induction effect

It is also possible to obtain the air flow rate induced in the room from the so-called induction factor ( $q_x/q_o$ ) which is determined by the parameters  $X_c$  in m (corrected throw) and the effective discharge area  $A_k$  in m<sup>2</sup>, according to the following figure.

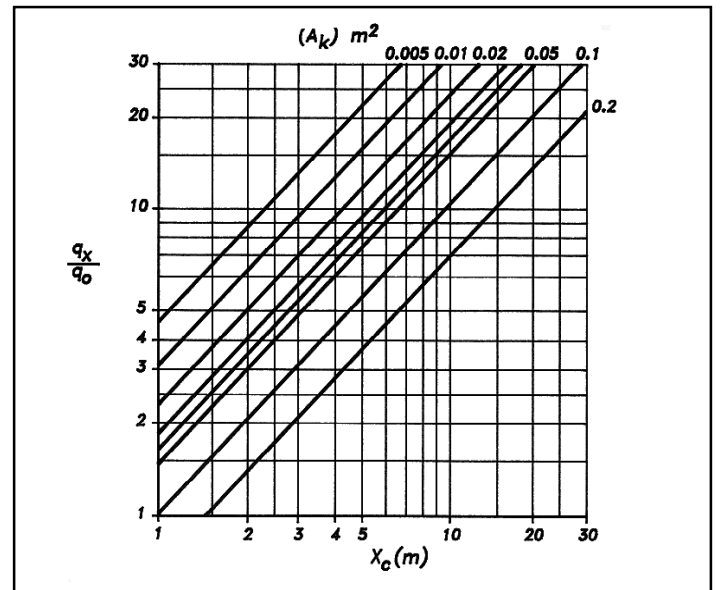

Once this induction factor is known the total induced volume is obtained by multiplication with the supply air flow rate.

# Accessories and mounting

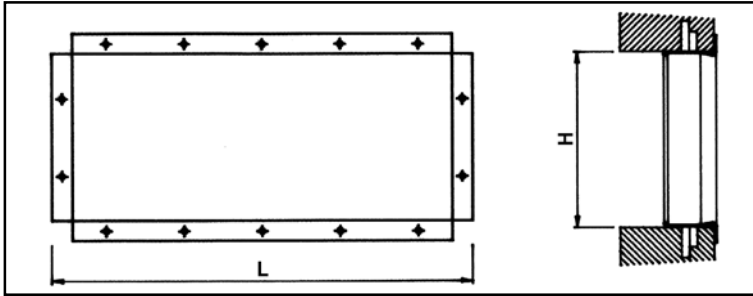

## Type MM

Metallic frame for grille mounting.

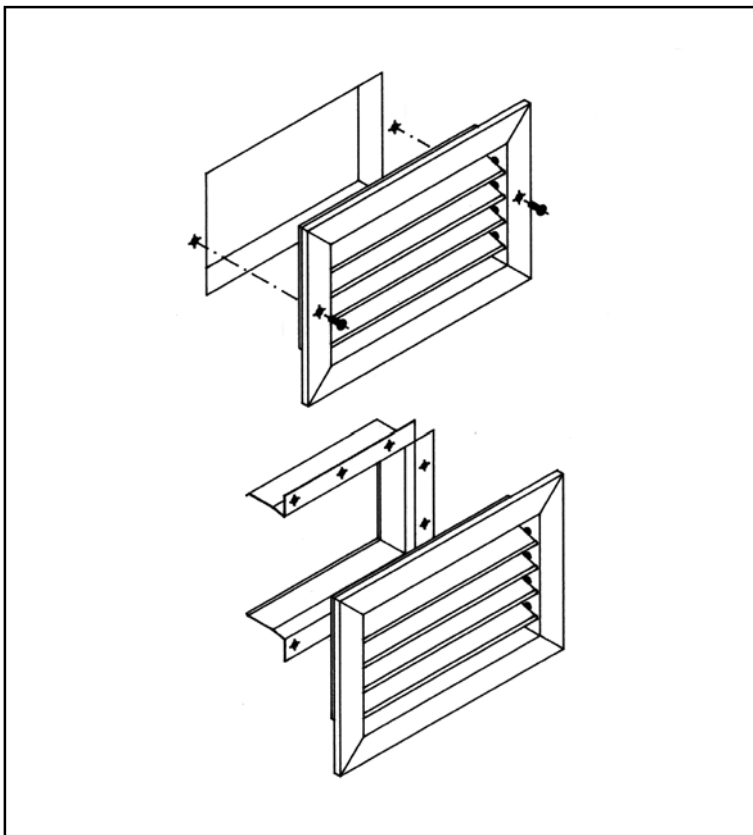

## Screw mounting

Placing the grille in the opening, it can be screwed directly onto the wall, sheet duct, etc. For mounting in fibre ducts it is recommended that the metallic mounting frame MM is used.

## Fixing with mounting frame

Once the metallic frame is located into the wall opening (fasteners are incorporated in the frame), the grille can be placed. Pressing lightly the grille will be attached perfectly to the mounting frame by means of pressure clips.

Note: The mounting frame is always provided with drilled holes, offering the possibility of screw mounting. This procedure is more usefull for larger grilles and recommended for mounting in ceilings.

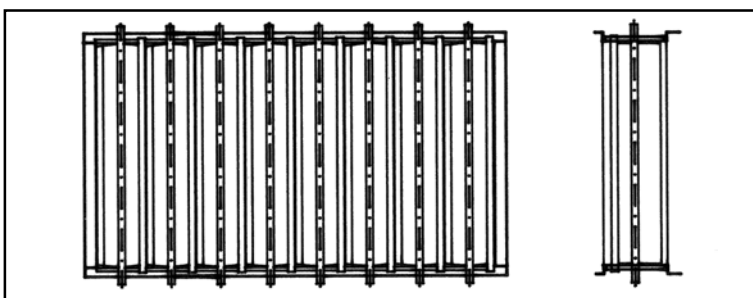

## Volume control damper 29-0

Volume control damper 29-0 is made of galvanised steel sheet with opposite blades. They can be applied to any type of grille (except filter holders and door grilles). It can easily be operated from outside by a screwdriver.



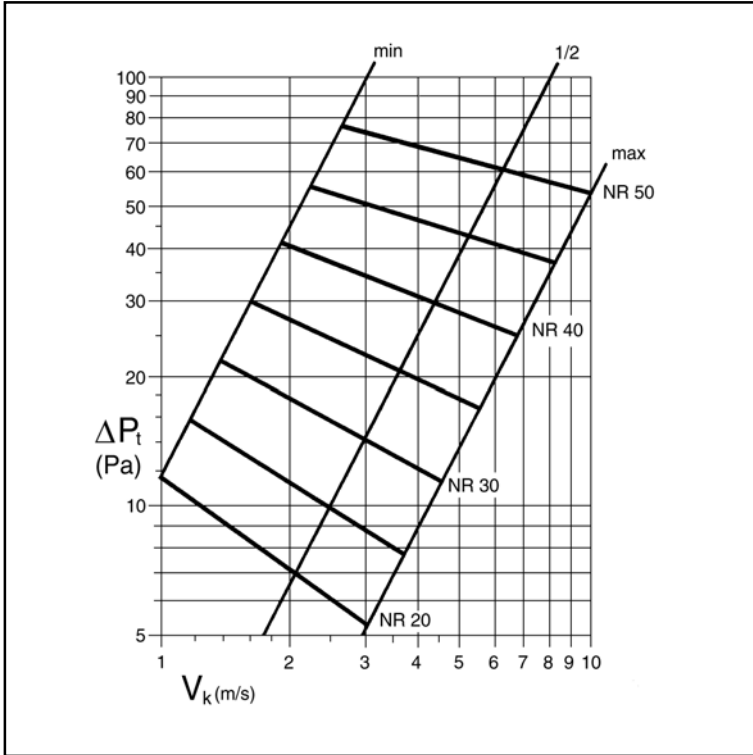

The volume control damper 29-0 modifies the values of sound level and pressure loss given in the selection tables.

Hereafter, and in the corresponding graph sound levels and total pressure losses ( $\Delta P_t$ ) are presented for the grille including the volume control damper as a function of the parameters  $V_k$  (effective velocity) and percentage of opening of the damper (min, 1/2, max.).

The graph expresses sound level NR as sound power level (without room attenuation) for the combination of grille and damper 29-0.

The value of  $V_k$  in the graph is that for the grille without damper.

$A_k$ (m <sup>2</sup> )	0,01	0,02	0,03	0,05	0,1	0,2
NR	-5,2	-1,9	0	+2,4	+5,8	+9,1

A correction factor should be applied to the sound level as a function of  $A_k$  (effective discharge area) according to this table.

**Normalised dimensions of the grilles (in mm)**

Length (L) 200, 250, 300, 350, 400, 450, 500, 600, 700, 800, 900, 1000

Heigth (H) 100, 150, 200, 250, 300, 350, 400, 450, 500, 600, 700, 800, 900, 1000

Special dimensions can be supplied upon request.

# Grilles for circular ducts (SUPPLY)

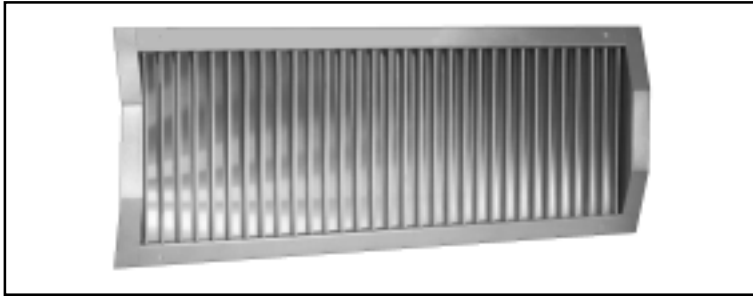

## Description

Type 21-SVC. Grilles of steel sheet for circular ducts with adjustable blades.

## Finishes

Steel sheet painted in gray colour.  
Special finishes available upon request.

## Dimensions

See table of dimensions on page 15.  
The dimensions of the opening are always L-5 mm x H-5 mm. For a grille of nominal size 425 x 225, the opening will have to be 420 x 220 mm.

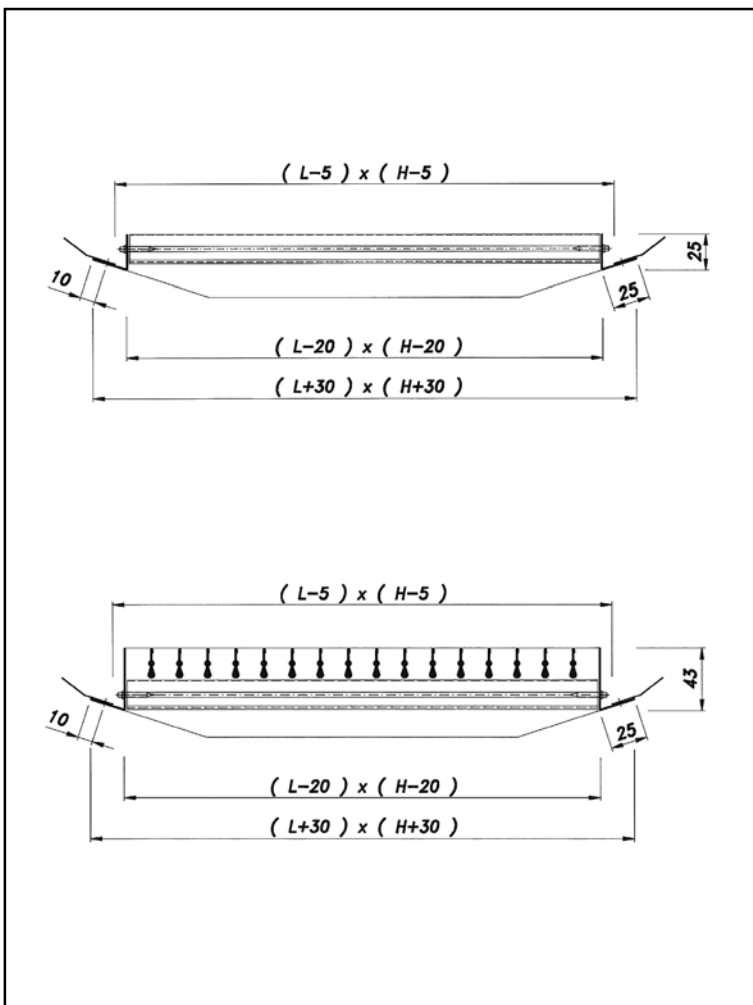

## Simple deflection, type SVC

## Mounting

Always by screwing onto the duct. Duct diameter from 400 to 1400 mm. (See table of dimensions on page 15)

## Double deflection, type DVC

## Identification

The grilles may be with single or double deflection, the first deflection being always with vertical blades. A metallic mounting frame does not exist for this type. In all descriptions of the grille dimensions it is understood that the first dimension is the length and the second the height.

<b>21</b>	Series, grilles of steel sheet
<b>SVC</b>	Single deflection, vertical blades
<b>DVC</b>	Double deflection, first blades vertical and second blades horizontal
<b>RFS-05</b>	Without indication, not incorporated
<b>RFS-06</b>	Volume control damper with inclination
<b>RFS-06</b>	Volume control damper without inclination
<b>L x H</b>	Length in mm (horizontal) x height in mm (vertical)

# Quick Selection Table (DOUBLE DEFLECTION)

Q		Dim. (mm)	425x75	525x75	625x75	425x125	525x125	625x125	425x225	525x225	625x225	825x225	1025x225
(m <sup>3</sup> /h)	(l/s)	A <sub>k</sub> (m <sup>2</sup> )	0,0130	0,0160	0,0190	0,0250	0,0310	0,0370	0,0490	0,0610	0,0730	0,0970	0,1220
100	27,8	V <sub>k</sub> (m/s)	2,1	1,7	1,5	1,1							
		X (m)	5,3	4,8	4,4	3,8							
		p <sub>t</sub> (Pa)	3,0	2,0	1,4	0,8							
		NR (dB)	7	3									
120	33,3	V <sub>k</sub> (m/s)	2,6	2,1	1,8	1,3	1,1						
		X (m)	6,4	5,8	5,3	4,6	4,1						
		p <sub>t</sub> (Pa)	4,3	2,9	2,0	1,2	0,8						
		NR (dB)	11	7	4								
140	38,9	V <sub>k</sub> (m/s)	3,0	2,4	2,0	1,6	1,3	1,1					
		X (m)	7,4	6,7	6,2	5,4	4,8	4,4					
		p <sub>t</sub> (Pa)	5,9	3,9	2,8	1,6	1,0	0,7					
		NR (dB)	15	11	7	2							
160	44,4	V <sub>k</sub> (m/s)	3,4	2,8	2,3	1,8	1,4	1,2					
		X (m)	8,5	7,7	7,0	6,1	5,5	5,0					
		p <sub>t</sub> (Pa)	7,7	5,1	3,6	2,1	1,4	1,0					
		NR (dB)	18	14	11	5	1						
180	50,0	V <sub>k</sub> (m/s)	3,8	3,1	2,6	2,0	1,6	1,4	1,0				
		X (m)	9,6	8,6	7,9	6,9	6,2	5,7	4,9				
		p <sub>t</sub> (Pa)	9,8	6,4	4,6	2,6	1,7	1,2	0,7				
		NR (dB)	21	17	14	8	4	1					
200	55,6	V <sub>k</sub> (m/s)	4,3	3,5	2,9	2,2	1,8	1,5	1,1				
		X (m)	10,6	9,6	8,8	7,7	6,9	6,3	5,5				
		p <sub>t</sub> (Pa)	12,1	8,0	5,6	3,3	2,1	1,5	0,8				
		NR (dB)	24	20	16	11	7	3					
250	69,4	V <sub>k</sub> (m/s)	5,3	4,3	3,7	2,8	2,2	1,9	1,4	1,1	1,0		
		X (m)	13,3	12,0	11,0	9,6	8,6	7,9	6,9	6,1	5,6		
		p <sub>t</sub> (Pa)	18,8	12,4	8,8	5,1	3,3	2,3	1,3	0,9	0,6		
		NR (dB)	29	25	22	16	12	9	3				
300	83,3	V <sub>k</sub> (m/s)	6,4	5,2	4,4	3,3	2,7	2,3	1,7	1,4	1,1		
		X (m)	16,0	14,4	13,2	11,5	10,3	9,5	8,2	7,4	6,7		
		p <sub>t</sub> (Pa)	27,1	17,9	12,7	7,3	4,8	3,3	1,9	1,2	0,9		
		NR (dB)	33	29	26	21	16	13	8	3			
350	97,2	V <sub>k</sub> (m/s)	7,5	6,1	5,1	3,9	3,1	2,6	2,0	1,6	1,3	1,0	
		X (m)	18,6	16,8	15,4	13,4	12,1	11,0	9,6	8,6	7,9	6,8	
		p <sub>t</sub> (Pa)	36,9	24,4	17,3	10,0	6,5	4,6	2,6	1,7	1,2	0,7	
		NR (dB)	37	33	30	24	20	17	11	7	3		
400	111,1	V <sub>k</sub> (m/s)	8,5	6,9	5,8	4,4	3,6	3,0	2,3	1,8	1,5	1,1	
		X (m)	21,3	19,2	17,6	15,3	13,8	12,6	11,0	9,8	9,0	7,8	
		p <sub>t</sub> (Pa)	48,2	31,8	22,6	13,0	8,5	6,0	3,4	2,2	1,5	0,9	
		NR (dB)	40	36	33	28	23	20	15	10	7	1	
450	125,0	V <sub>k</sub> (m/s)	9,6	7,8	6,6	5,0	4,0	3,4	2,6	2,0	1,7	1,3	1,0
		X (m)	23,9	21,6	19,8	17,3	15,5	14,2	12,3	11,1	10,1	8,8	7,8
		p <sub>t</sub> (Pa)	61,0	40,3	28,6	16,5	10,7	7,5	4,3	2,8	1,9	1,1	0,7
		NR (dB)	43	39	36	31	26	23	17	13	10	4	
500	138,9	V <sub>k</sub> (m/s)	10,7	8,7	7,3	5,6	4,5	3,8	2,8	2,3	1,9	1,4	1,1
		X (m)	26,6	24,0	22,0	19,2	17,2	15,8	13,7	12,3	11,2	9,7	8,7
		p <sub>t</sub> (Pa)	75,3	49,7	35,3	20,4	13,2	9,3	5,3	3,4	2,4	1,4	0,9
		NR (dB)	46	42	38	33	29	25	20	16	12	7	2
600	166,7	V <sub>k</sub> (m/s)	12,8	10,4	8,8	6,7	5,4	4,5	3,4	2,7	2,3	1,7	1,4
		X (m)	31,9	28,8	26,4	23,0	20,7	18,9	16,4	14,7	13,5	11,7	10,4
		p <sub>t</sub> (Pa)	108,5	71,6	50,8	29,3	19,1	13,4	7,6	4,9	3,4	1,9	1,2
		NR (dB)	50	46	43	38	33	30	24	20	17	11	7
700	194,4	V <sub>k</sub> (m/s)	15,0	12,2	10,2	7,8	6,3	5,3	4,0	3,2	2,7	2,0	1,6
		X (m)	37,2	33,6	30,8	26,9	24,1	22,1	19,2	17,2	15,7	13,6	12,2
		p <sub>t</sub> (Pa)	147,7	97,5	69,1	39,9	26,0	18,2	10,4	6,7	4,7	2,7	1,7
		NR (dB)	54	50	47	41	37	34	28	24	20	15	10
800	222,2	V <sub>k</sub> (m/s)		13,9	11,7	8,9	7,2	6,0	4,5	3,6	3,0	2,3	1,8
		X (m)		38,4	35,2	30,7	27,6	25,2	21,9	19,7	18,0	15,6	13,9
		p <sub>t</sub> (Pa)		127,3	90,3	52,1	33,9	23,8	13,6	8,8	6,1	3,5	2,2
		NR (dB)		53	50	45	40	37	31	27	24	18	14
900	250,0	V <sub>k</sub> (m/s)			13,2	10,0	8,1	6,8	5,1	4,1	3,4	2,6	2,0
		X (m)			39,6	34,5	31,0	28,4	24,7	22,1	20,2	17,5	15,6
		p <sub>t</sub> (Pa)			114,3	66,0	42,9	30,1	17,2	11,1	7,7	4,4	2,8
		NR (dB)			53	47	43	40	34	30	26	21	16
1000	277,8	V <sub>k</sub> (m/s)			14,6	11,1	9,0	7,5	5,7	4,6	3,8	2,9	2,3
		X (m)			44,0	38,4	34,5	31,5	27,4	24,6	22,5	19,5	17,4
		p <sub>t</sub> (Pa)			141,1	81,5	53,0	37,2	21,2	13,7	9,6	5,4	3,4
		NR (dB)			55	50	46	42	37	33	29	23	19
1200	333,3	V <sub>k</sub> (m/s)				13,3	10,8	9,0	6,8	5,5	4,6	3,4	2,7
		X (m)				46,0	41,3	37,8	32,9	29,5	26,9	23,4	20,8
		p <sub>t</sub> (Pa)				117,3	76,3	53,6	30,5	19,7	13,8	7,8	4,9
		NR (dB)				54	50	46	41	37	33	28	23
1400	388,9	V <sub>k</sub> (m/s)					12,5	10,5	7,9	6,4	5,3	4,0	3,2
		X (m)					48,2	44,2	38,4	34,4	31,4	27,3	24,3
		p <sub>t</sub> (Pa)					103,9	72,9	41,6	26,8	18,7	10,6	6,7
		NR (dB)					54	50	45	41	37	32	27
1600	444,4	V <sub>k</sub> (m/s)					14,3	12,0	9,1	7,3	6,1	4,6	3,6
		X (m)					55,1	50,5	43,9	39,3	35,9	31,2	27,8
		p <sub>t</sub> (Pa)					135,7	95,2	54,3	35,0	24,5	13,9	8,8
		NR (dB)					57	54	48	44	40	35	30

**Correction factors for grilles with single deflection 21 SVC:**

V<sub>k</sub> = Table value x 0,8  
 X = Table value x 1,1  
 P<sub>t</sub> = Table value x 0,8  
 NR = Table value - 2 dB

**Symbols:**  
 V<sub>k</sub> = Effective velocity in m/s  
 X = Throw in m  
 P<sub>t</sub> = Total pressure loss in Pa  
 NR = Sound level index in dB  
 A<sub>k</sub> = Effective area in m<sup>2</sup>

NR > 40

NR 30 - 40

NR < 10

NR 10 - 20

NR 20 - 30

# General information

## Explanatory notes on the table

- This selection table is based on full-scale laboratory tests in accordance with standards ISO 5219 (UNE 100.710) and ISO 5135 and 3741. These tests have been performed with supply grilles 21 DVC. To calculate the values for the single deflection grilles 21 SVC the correction factors as given in the table should be applied.
- The ATU (Air Terminal Unit) is placed in the center of the room with a free jet.
- The blade angle is  $0^\circ$  both in vertical as in horizontal (see fig. 16 for correction factors for other blade angles)
- The difference in temperature of supply air and room air,  $\Delta t$  is  $8^\circ \text{C}$
- The sound level index NR is based on the sound power level without room attenuation and without damper and mounted as indicated in the following figure, where  $V_c \leq 0,5 V_k$  ( $V_c$  = velocity in duct and  $V_k$  = effective velocity of the grille).

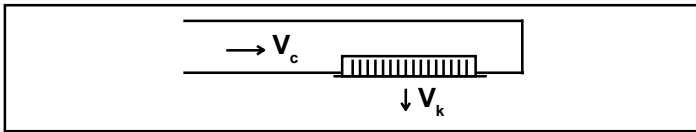

- To obtain the pressure loss or sound level of grille with damper, see the corresponding graph on page 16. (Graph for grille + damper)

## Selection by table of supply grilles for circular ducts, series 21 (21 SVC and 21 DVC)

The parameters in the selection table are the following:

- $V_k$  = Effective velocity of air discharge in m/s
- $X^k$  = Throw for a terminal velocity of 0,25 m/s (free jet)
- $P_t$  = Pressure loss in Pa
- NR = Sound level

The selection should take into account, for a given air flow rate, sound level and throw for a desired terminal velocity. The throws which appear in the table correspond to a terminal velocity of 0,25 m/s.

## Example of selection:

### Requirements:

Air flow rate: \_\_\_\_\_ 400 m<sup>3</sup>/h  
 Throw \_\_\_\_\_ 10 m  
 Sound level \_\_\_\_\_ below NR 45  
 Application \_\_\_\_\_ Gym  
 Pressure loss \_\_\_\_\_ below 10 Pa  
 Effective velocity \_\_\_\_\_ 2 to 4 m/s

### Solution:

From the selection table for supply grilles for circular ducts can be obtained:

Q (Air flow rate) \_\_\_\_\_ 400 m<sup>3</sup>/h (111,1 l/s)  
 $V_k$  (Effective velocity) \_\_\_\_\_ 2,3 m/s  
 $X^k$  (Throw) \_\_\_\_\_ 11 m for  $0^\circ$  blade angle  
 $P_t$  (Pressure loss) \_\_\_\_\_ 3,4 Pa  
 NR (Sound level) \_\_\_\_\_ 15

Grille 21 DVC of 425 x 225

Observing the results, the requirements of the project are satisfied.

## Correction factor

A correction factor exists for the angle of the first blade row (vertical blades). This factor,  $C_a$ , affects appreciably the real, or corrected, throw  $X_c$ . If in the above mentioned example the blade angle would have been  $15^\circ$ , the corrected throw would have been:

$$X_c = X \cdot C_a \quad X_c = 11 \cdot 1,35 \quad X_c = 14,9 \text{ m.}$$

Fig. 16

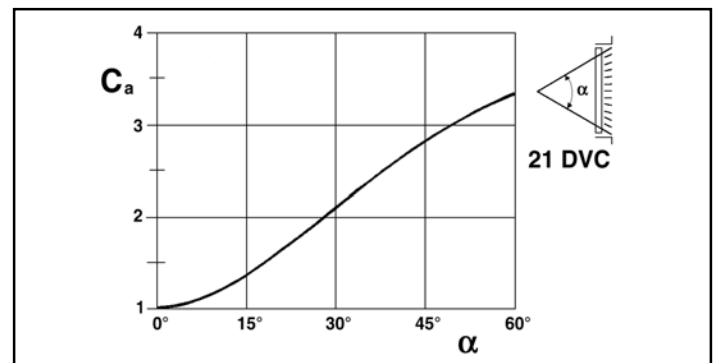
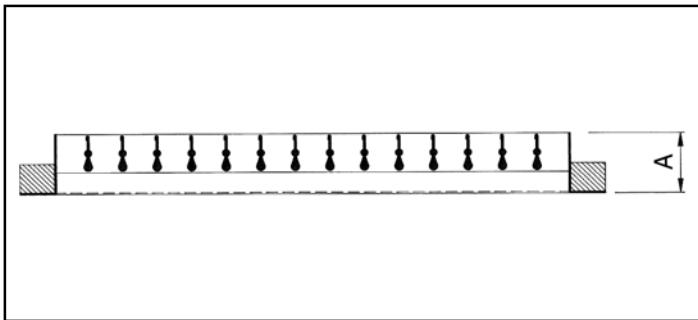

**Table of general dimensions**

L x H (mm)	THICKNESS OF UNIT						Ø	
	A	B	C	D	E	F	MIN.	MAX.
425 x 75	25	43	50	95	70	105	160	400
525 x 75	25	43	50	105	70	115	160	400
625 x 75	25	43	50	115	70	125	160	400
425 x 125	34	52	60	105	80	115	315	900
525 x 125	34	52	60	115	80	125	315	900
625 x 125	34	52	60	125	80	135	315	900
425 x 225	43	61	70	115	90	125	630	1.400
525 x 225	43	61	70	125	90	135	630	1.400
625 x 225	43	61	70	130	90	140	630	1.400
825 x 225	43	61	70	130	90	140	630	1.400
1.025 x 225	43	61	70	130	90	140	630	1.400

(Ø) Circular duct diameters

**Single deflection SVC**



**Single deflection SVC with damper RFS-05**

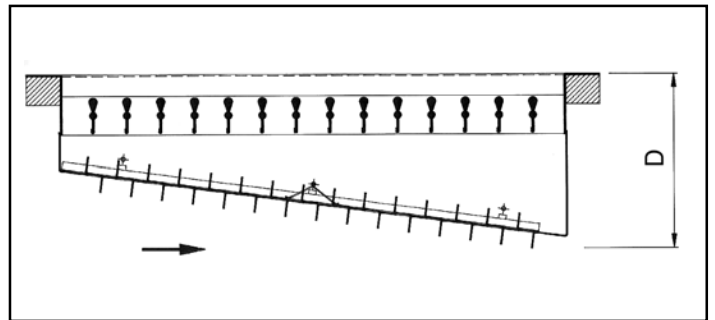

**Double deflection DVC**

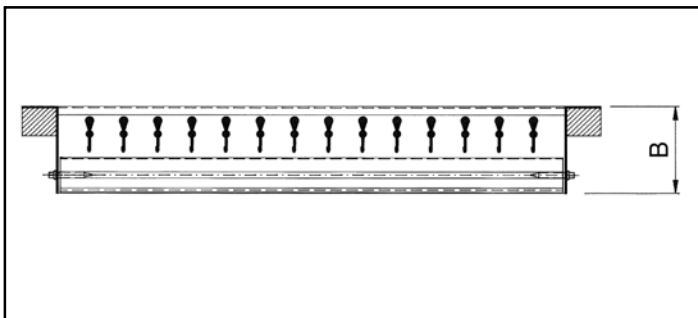

**Double deflection DVC with damper RFS-06**

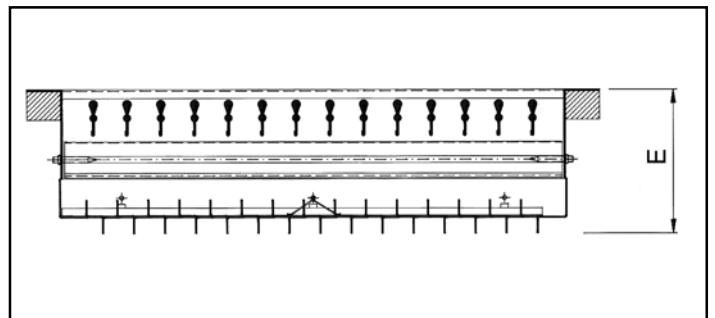

**Single deflection SVC with damper RFS-06**

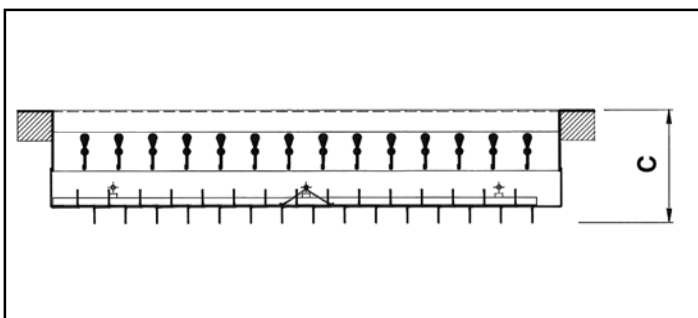

**Double deflection DVC with damper RFS-05**

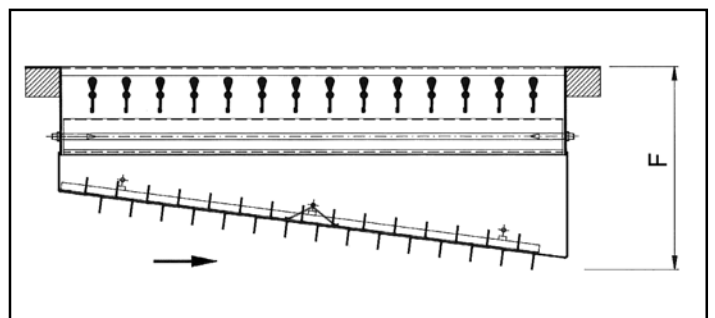

### Induction effect

It is possible to determinate the air flow rate induced in the room by means of the so-called induction factor  $q_x/q_0$  which is defined by the parameters  $X_c$  in m (corrected throw) and the discharge area in  $m^2$ , according to the following figure.

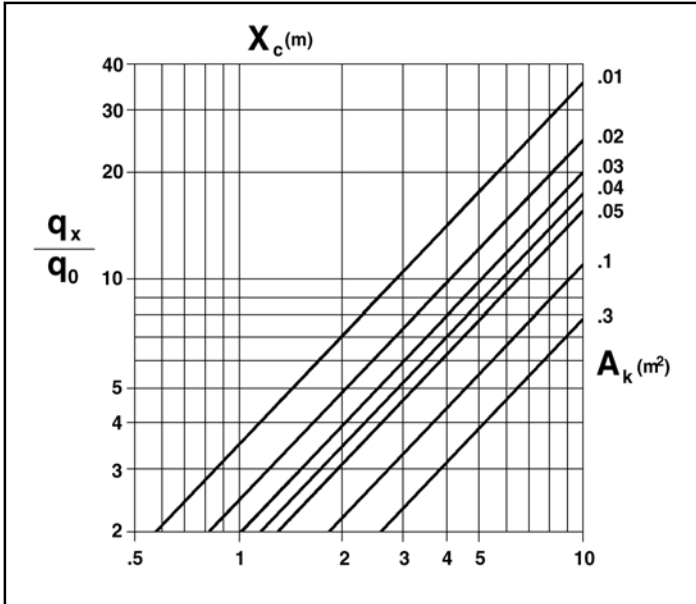

### Volume control dampers RFS-06 and RFS-05 for grilles for circular ducts series 21 (21 SVC AND 21 DVC)

The dampers RFS-06 and RFS-05, connected to the grilles for circular ducts, modify the values of sound level and pressure loss presented in the selection table.

In the following graph sound levels and total pressure losses ( $\Delta P_t$ ) of the grille with damper are given. The graph should be entered with parameters  $V_k$  (effective velocity) and percentage of opening of the damper (min, 1/2, max)

The graph is based on tests with the RFS-05 damper, although later tests have demonstrated that the difference with the RFS-06 (straight) is negligible.

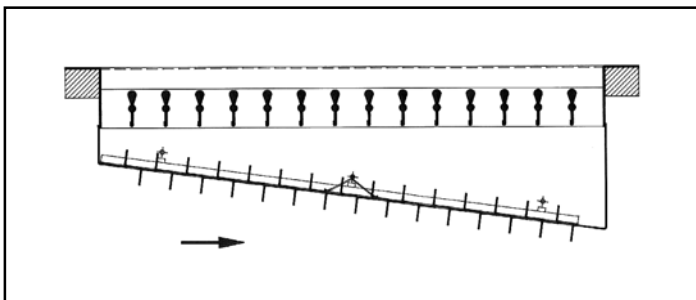

### Graph for grille + damper

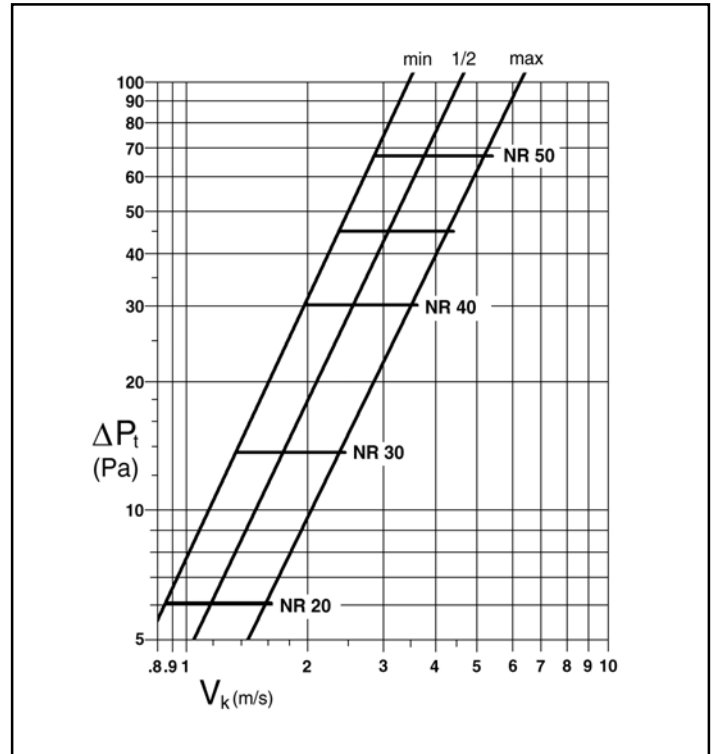

The graph presents sound level NR as sound power level (without room attenuation) for the combination of grille and damper RFS-05. The value of  $V_k$  on the graph is that for the grille without damper.

### Corrections to the sound level

There exist two types of corrections, one for the  $A_k$  (effective discharge area) and the other for the existing ratio between duct velocity ( $V_c$ ) and effective grille velocity ( $V_k$ ). These corrections affect the sound level as follows:

#### 1. Correction for discharge area:

$A_k$ ( $m^2$ )	0,01	0,02	0,03	0,05	0,1
NR	-4,4	-1,6	0	+2,1	+4,8

#### 2. Correction for ratio between velocity in duct and effective velocity:

$V_c/V_k$	0	1	1,4	1,7	2
NR	-3,5	-3,5	-1,5	0	+1,5

## Usefull recommendations

### Measurement of air flow rate

The air flow rate ( $q_v$ ) is obtained from the product of the effective area of the grille ( $A_k$ ) and its effective velocity ( $V_k$ ):

$$q_v(\text{m}^3/\text{h}) = A_k(\text{m}^2) \cdot V_k(\text{m/s}) \cdot 3600$$

The values for both  $A_k$  and  $V_k$  are specified in the selection table

To obtain  $V_k$  use is recommended of a probe Alnor 2220 or 6070 P.

If a hot-wire anemometer is used (e.g. type TSI-VELOCICALC), the velocity obtained should be multiplied by 1,3.

### Measurement with probe Alnor

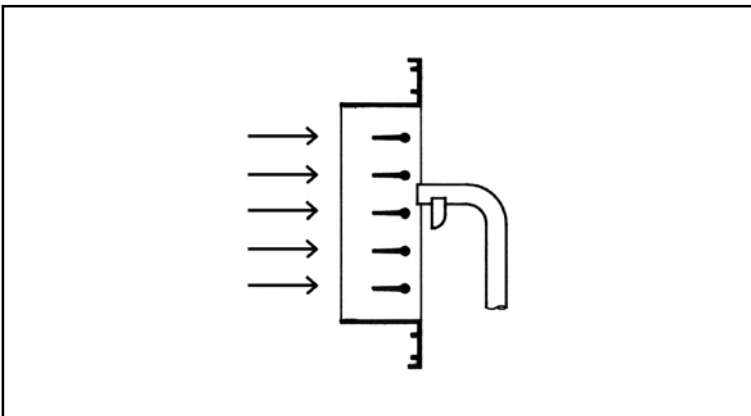

## General information

Due to the simple construction of the damper RFS-06 and RFS-05 (sliding type), they offer simple operation, displacing the slide by a screw driver. This permits a correct balancing of the pressure in the duct system.

The grilles for circular ducts can also be used for return air, in which case it is recommended to use the single deflection grille 21 SVC, with damper RFS-06 where necessary.

Technical data for selection of grilles 21 SVC for return applications are similar to those for a standard return grille with fixed blades (e.g. 20-45-V).

# Information of general interest

## Sound levels, NR curves

Hereafter, recommended sound levels for each type of installation are given.

Application	NR
Recording/television studios .....	15
Concert halls, operation rooms, libraries .....	20
Conference rooms, churches, residences, hotels, private offices .....	25-30
Banks, cafeterias, theatres, schools, restaurants, public buildings .....	35-40
Supermarkets, shopping malls, gyms .....	45-55
Shops, light industry .....	65

The NR system, which gradually will replace the NC system, has the advantage of including corrections which apply to the specified criterions, taking into account the type of noise, its duration and its location (see graph and following corrections).

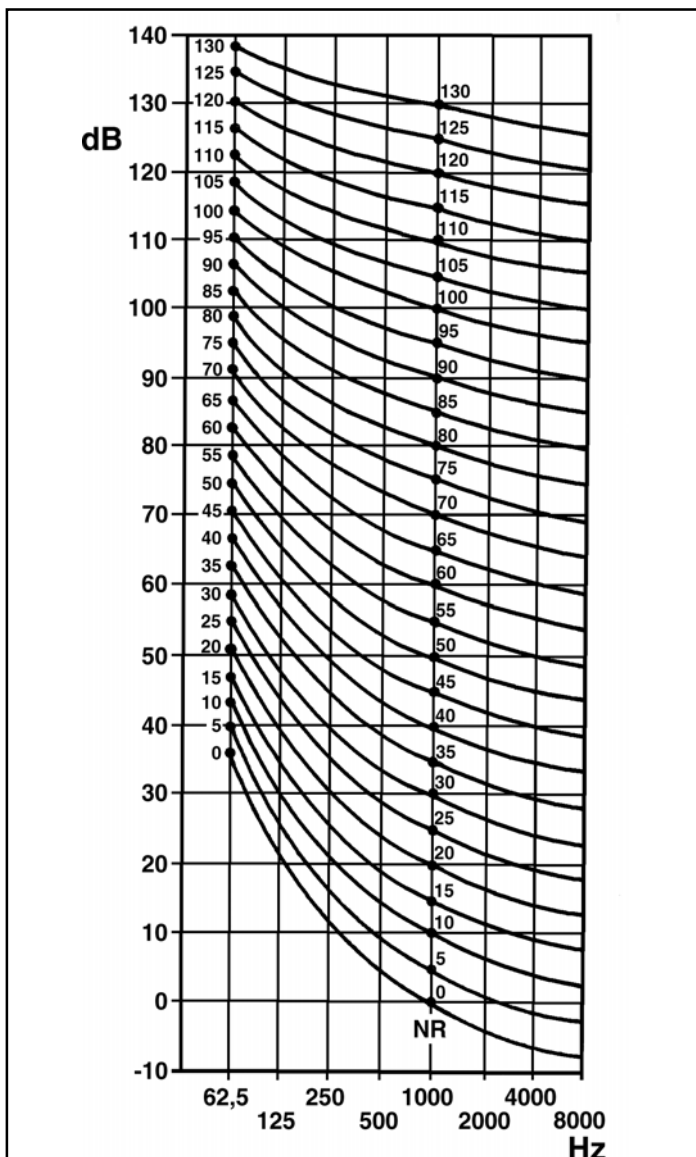

## Corrections

Corrections	dB
a) Pure tone, easily audible .....	-5
b) Variable duration or intermittent .....	-5
c) Noise only during working hours .....	+5
d) Noise during 25% of the time .....	+5
5% .....	+10
1,5% .....	+15
0,5% .....	+20
0,1% .....	+25
0,02% .....	+30
e) Residential suburbs .....	-5
Suburbs .....	0
Urban residential areas .....	+5
Urban areas close to light industry .....	+10
Industrial areas .....	+15

## Recommended velocities for air distribution units

The values given below are approximate and refer to comfort installations, since for industrial applications they may be higher. In any case these data should be treated as orientative

Type of terminal unit	Use	(m/s)
Grilles with single and double deflection	supply	2-3,5
Grilles with blades fixed at 45°	return	1,5-2,5
Grilles with filter holder	return	1,5-2,5
Grilles for circular ducts with single and double deflection	supply	2-4
Grilles for circular ducts with single deflection	return	1,5-3
Egg crate grilles	return	2-3
Door grilles	air transfer	0,75-1,25
Louvres	supply or return	2,5-4,5
Linear grilles, wall or ceiling	supply	2-3,5
Linear grilles, wall or ceiling	return	1,5-2,5
Linear grilles, floor	supply	1,5-2,5
Linear grilles, floor	return	1,5-2,5
Linear grilles for fan-coils or induction units	supply	2,5-4
Linear grilles for fan-coils or induction units	return	1,5-2,5
Linear grilles for air curtains	supply	3-6
Linear grilles for air curtains	return	2,5-4
Circular diffusers with fixed cones	supply	2-3
Circular diffusers with movable cones	supply	2,5-4,5
Extract valves	return	1-1,5
Ball diffusers	supply	3-9
Square and rectangular diffusers	supply	2-3,5
Linear diffusers	supply	2,5-4,5
Linear diffusers	return	1,5-2,5